

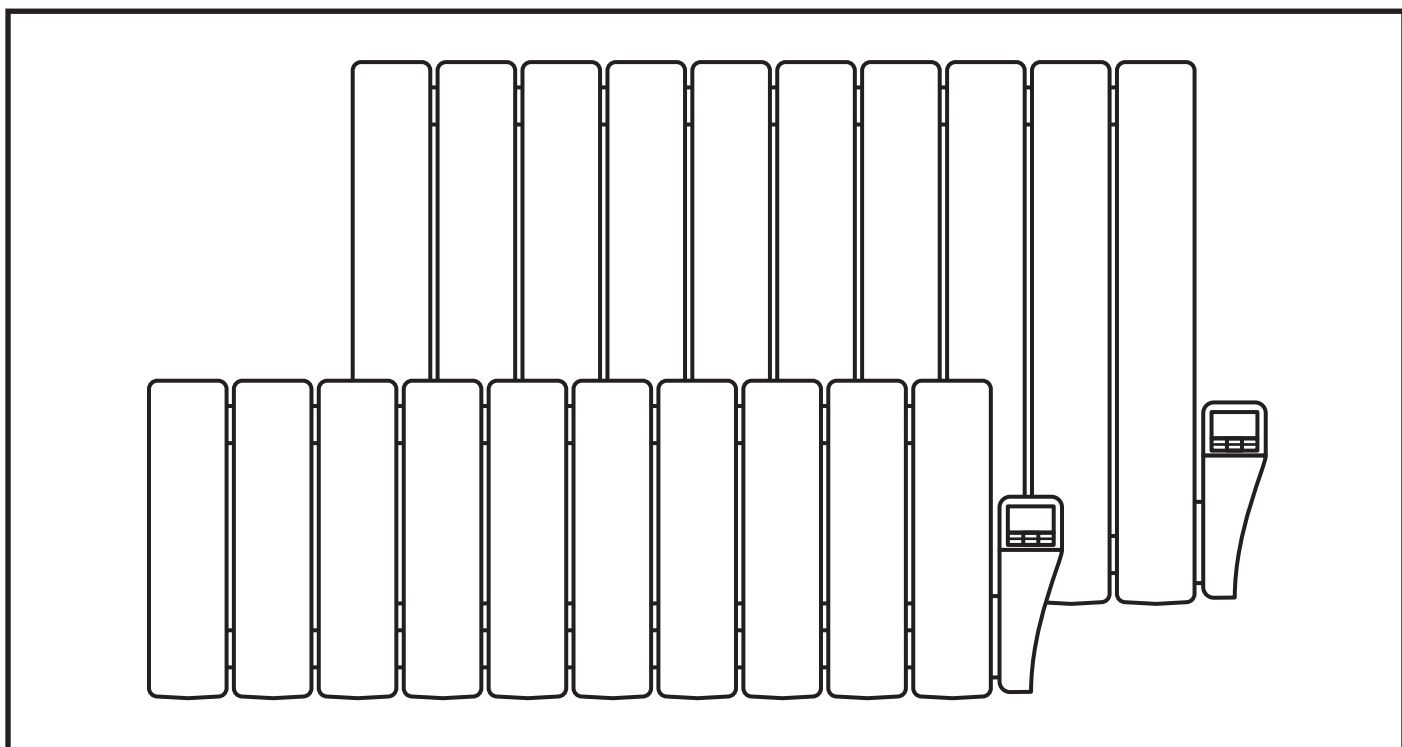

Richmond DPL & DP

Low Level & Full Height Thermal Electric Radiator

Installation and Operation Guide



Models

Type	Wattage	No. of Fins	Size (WxHxD) (mm)			Net Weight (kg)
DPL 10	950	10	865	340	96	12.8
DPL 15	1425	15	1265	340	96	19.2
DP 450	450	3	310	575	96	6.1
DP 600	600	4	390	575	96	8.1
DP 900	900	6	550	575	96	11.8
DP 1200	1200	8	710	575	96	15.7
DP 1500	1500	10	870	575	96	19.3
DP 1800	1800	12	1030	575	96	25.7

Installation

Main Principles

This appliance must be connected to a 230V 50Hz power supply. This appliance must be connected to a switched fused spur or a plug. Main installation must be provided by an omnipolar device where the distance between contacts must be a minimum of 3mm.

Power Cord Wires = Neutral (Grey or Blue)
 Live (Brown)
 Pilot-Wire (Black)

IF PILOT WIRE IS NOT REQUIRED INSULATE BLACK CABLE TO ENSURE IT DOES NOT COME INTO CONTACT WITH ANY OTHERS WIRES OR TERMINALS.

The replacement of the power cable, if necessary, should be completed by a qualified electrician authorised by the importer.

Precautions to be Taken

The radiator must be placed far from any inflammable material and should not be used by unsupervised children.



The radiator should never be covered by clothes, other materials or objects. It should never be placed in enclosed spaces or areas which might prevent the free circulation of air around the radiator.

Important Safety Information

Whilst in operation, the appliance must not be covered to avoid over-heating. If the appliance is covered and the safety over-heat switch is activated, the element will need replacing. This is not covered by the warranty.

This appliance is a Class 2 double insulated appliance and should not be used or connected in the wet zone of a bathroom or kitchen. The appliance should be placed at a distance that makes it impossible for a person taking a bath or shower to touch the switches and thermostat unit.

Do not place the radiator under a power socket.

Should the appliance have to be repaired in the first instance please contact the supplier of the radiator.

The minimum distance needed to allow air circulation is 150mm.

This unit contains a precise amount of synthetic heating fluid inside the fins which must only be opened by the manufacturer.

The standard rules about recycling and removal of synthetic heating fluid should be followed once the appliance is no longer in use.

Children of less than 3 years should be kept away unless continuously supervised.

Children aged from 3 years and less than 8 years shall only switch on/off the appliance provided that it has been placed or installed in its intended normal operating position and they have been given supervision or instruction concerning use of the appliance in a safe way and understand the hazards involved.

Children aged from 3 years and less than 8 years shall not plug in, regulate and clean the appliance or perform user maintenance.

CAUTION — Some parts of this product can become very hot and cause burns. Particular attention has to be given where children and vulnerable people are present.

Directions for the Installer

Installation should only be completed by a qualified professional.

Electric Power

The electrical circuits within your house should be of the correct type and size for the appliance wattage.

We recommend that the fused spur outlet is placed 10cm to the right of the appliance and 15cm from the floor.

The appliance is supplied with approximately 1.5m of power cable without a plug. The electrical circuit should be isolated by means of an omni-polar cutting system either by a switch or magnetothermic protecting device.

Main Components

The Richmond DPL body consists of special cast aluminium fins, specifically designed to ensure a maximum rate of heat diffusion, the air circulation channels providing a very effective convection effect.

The aluminium body contains a special heat conducting fluid, filled inside the fins with a unique procedure assuring a bubble-free content for a total uniform and silent delivery of heat.

Fitting the Appliance

The appliance should be hung as close as possible to the coolest wall in the room, however it is not recommended to place it on a wall that is not properly insulated – if this is the case, the part of the wall behind the unit should be insulated.

In a bathroom, the appliance must be placed within the protected zone and should not be reachable, directly or indirectly by a person in the shower or bath.

The appliance should, by no means, be placed under a connecting plug.

To hang the radiator, place the radiator on the floor in the position it is to be installed. Locate the bracket above the radiator with the point on the bracket being between the first and second element on both sides (figure 1.a). For radiators with more than 9 elements, the bracket should be placed between the second and third element (figure 1.b).

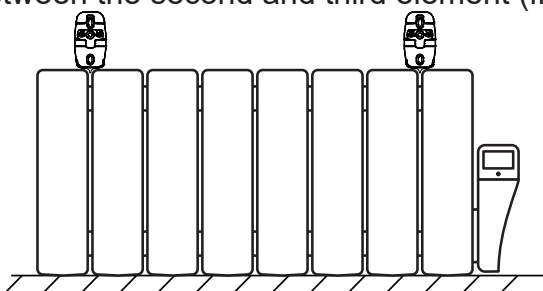

Figure 1.a

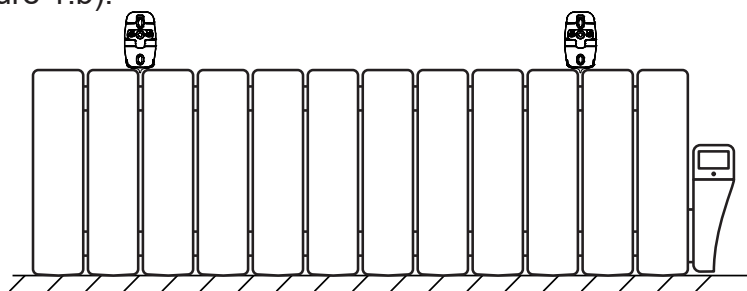
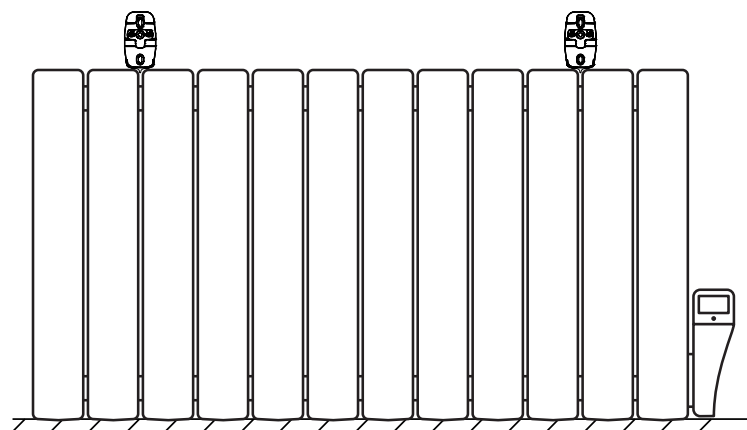
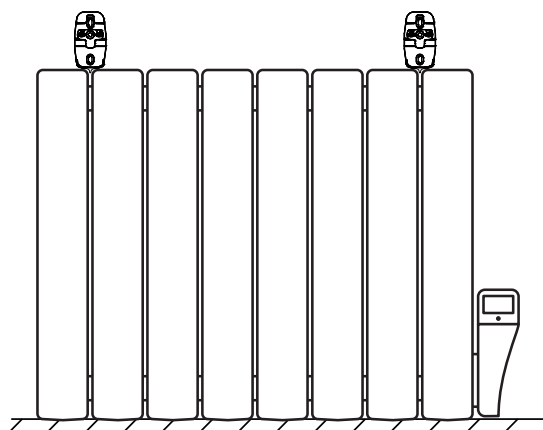

Figure 1.b



Mark the appropriate location and fix the brackets in place with the supplied plugs and screws, ensuring the brackets are installed in the correct position (figure 2).

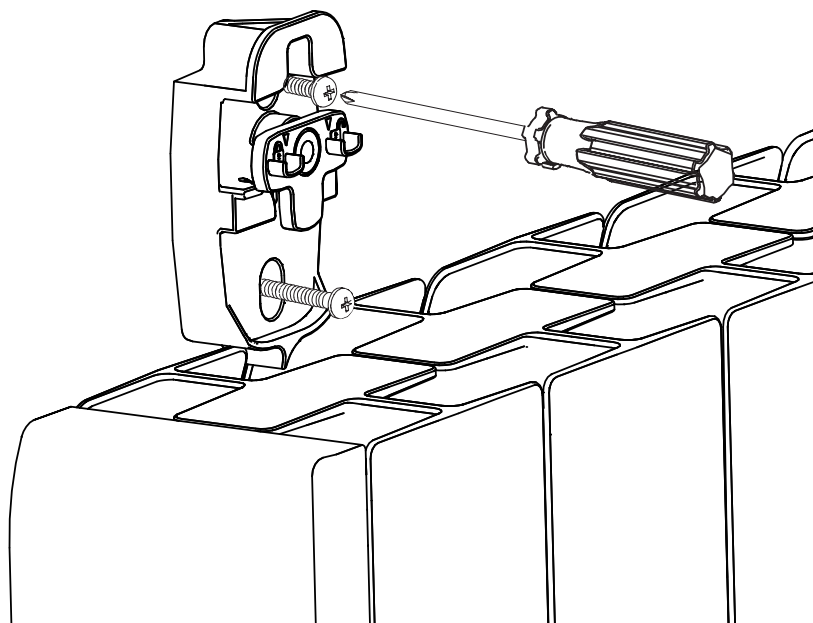

Figure 2

Once the brackets have been installed the radiator can be hung from the supports (figure 3). To lock the radiators in place press on the ratchet and turn until a click is heard (figure 4).

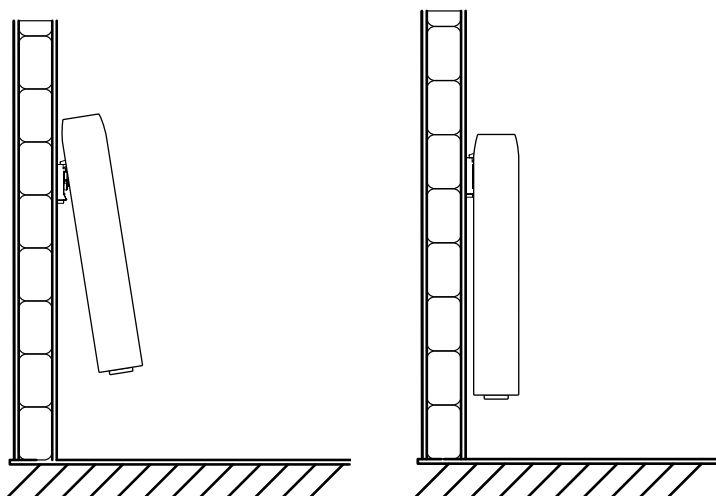

Figure 3

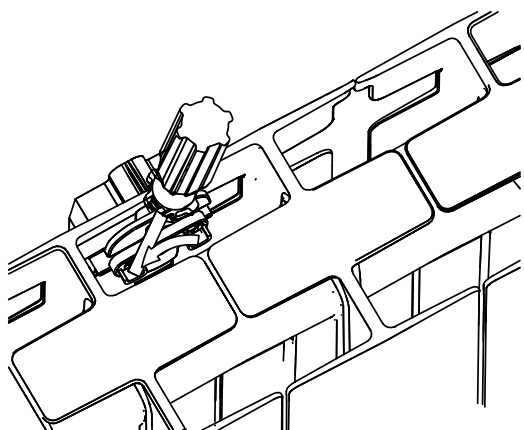
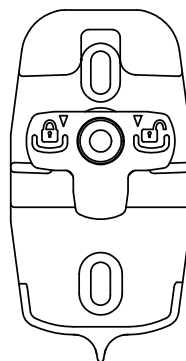
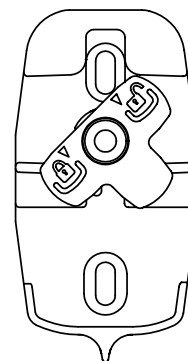

Figure 4



Unlocked



Locked

Operation

The room temperature is controlled by the electronic thermostat in the control end located on the side of the appliance. The thermostat has a precision of $\pm 0.3^{\circ}\text{C}$.

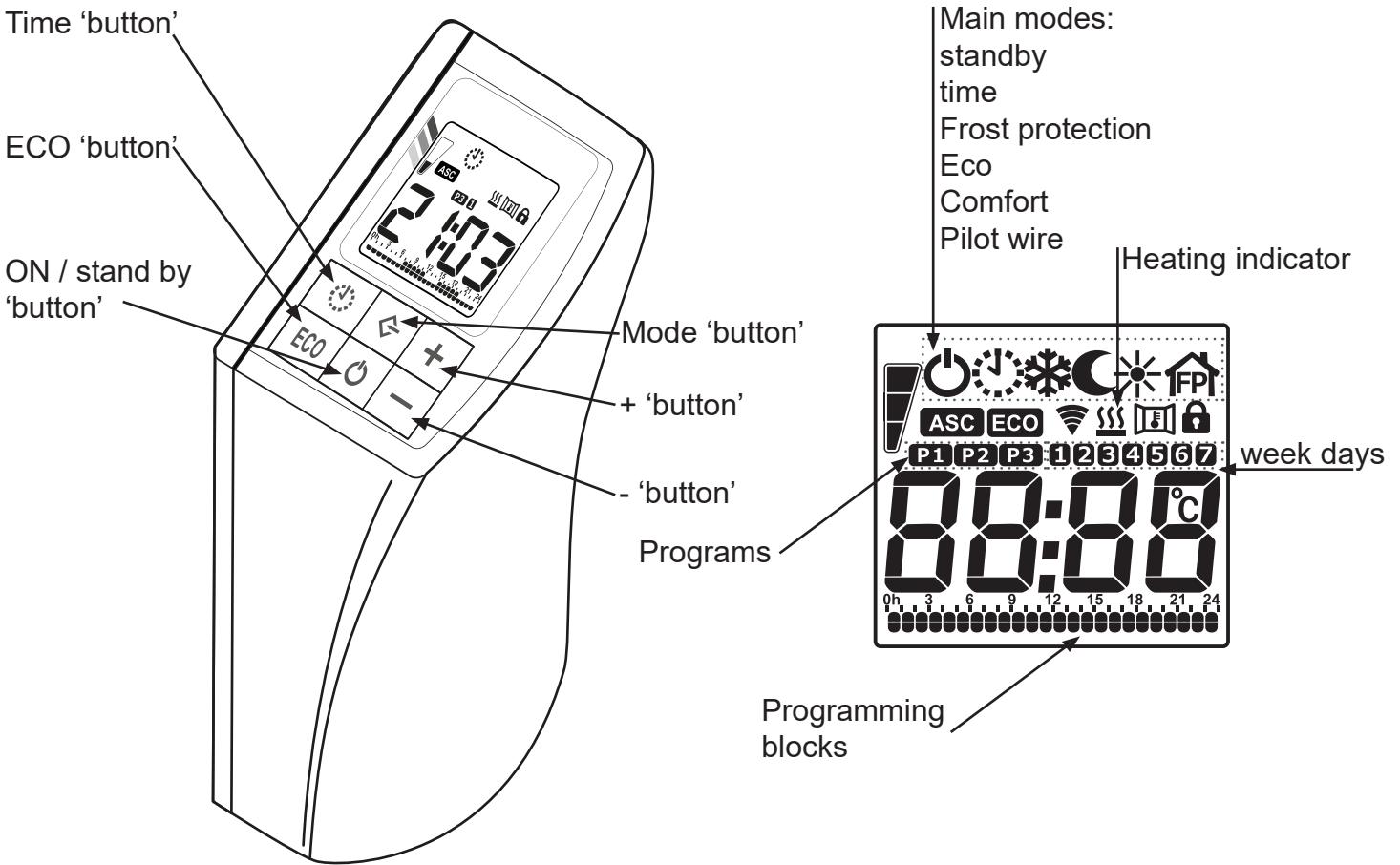

Controller: Buttons and Symbols

Switching On

Once power has been supplied to the radiator it will initially be in the standby mode.

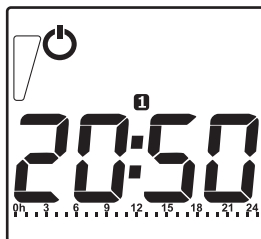

stand by

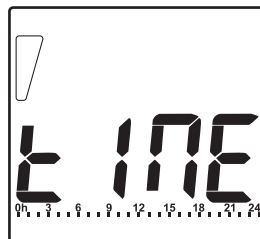



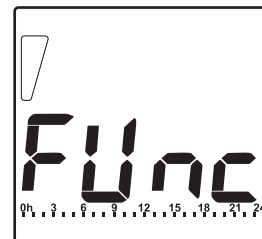

Time



Function

Setting the Clock

1. In the Stand-by mode press and hold the time button  for more than 3 seconds.
2. Press the + or - button to until Time is shown on the screen, then press the Mode  button
3. Select the current day of the week by using either the + or - button, then press the Mode  button to validate
4. Use either the + or - button to select the hour and then press the Mode  button to validate. Repeat this process for the minutes.

Once you have pressed the Mode button after selecting the minutes you will return to the Stand-by screen.

Mode Change

Press the Mode button to change between the mode screens shown below:

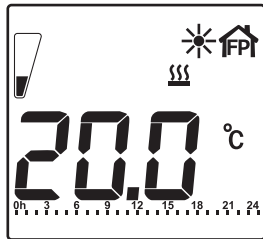

Pilot wire

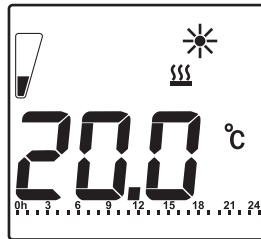

Comfort

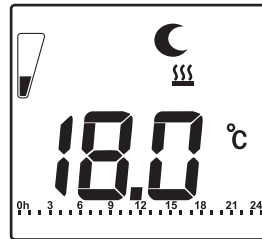

Economy

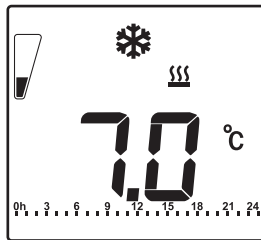

Frost Protection

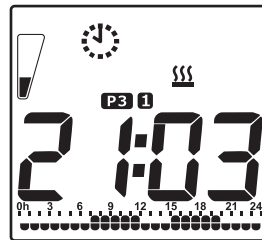

Programme

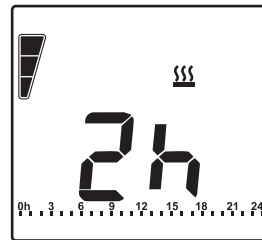

2hr Boost

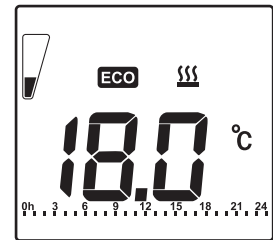

ECO mode

Pilot Wire

When in the pilot wire mode and if connected to a spate pilot wire controller the appliance can receive four type of control signal:

1. Comfort (required temperature set by the user)
2. Economy (fixed at 3.5°C less than comfort)
3. Frost Protection (7°C)
4. Stand-by

Comfort Temperature Setting

Press the Mode  button until comfort is selected, then press the + or - to adjust the temperature. Pressing either button continuously for more than 5 seconds will change the temperature rapidly.

The temperature ranges between 7°C and 32°C.

Economy Temperature Setting

Press the Mode  button until economy is selected, then press the + or - to adjust the temperature. Pressing either button continuously for more than 5 seconds will allow the value to change rapidly.

Frost Protection Setting

Press the Mode button until frost protection is selected. This will maintain the room temperature at 7°C.

2-Hour Boost

This mode will force continued heating for 2 hours independent of room temperature, after this time the radiator will enter the standby mode automatically. When the radiator is turned on again it will enter the programme mode.

ECO Mode

This mode is set 3°C lower than the current mode temperature regardless of other radiator settings. This mode only works in Pilot Wire, Comfort, Economy and Programme.

To activate / deactivate the function, press the dedicated [ECO] button.

Programme Mode

The programme mode has three programs which can be amended by the user (P1, P2, P3).

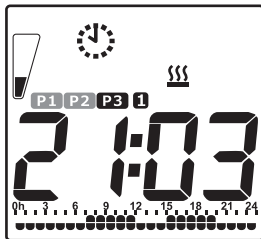

To select a programme, press the mode  until the Programme mode is selected. Then press the time button to select either P1, P2 or P3.

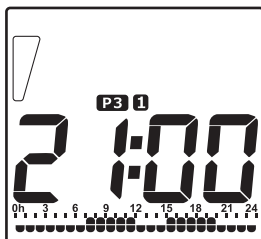

To edit a programme:

1. Press and hold the time  button for more than 3 seconds and then 00:00 will be shown on the display.
2. Use the + and – buttons to programme whether the radiator is programmed as either Comfort (+) or Economy (-) for each hour. The current hour being programmed will be shown on the display.
3. Once you have programmed day 1 and are satisfied with the programme, press the Mode button to move to the next day. When you press the Mode button the programme from day 1 will be automatically copied to day 2.



4. Repeat steps 2 and 3 for the rest of week.

Keypad Lock

To lock the keypad press the mode  button and hold for 3 seconds. A padlock  symbol will appear on the screen to signify it being locked.

To unlock the keypad press the mode  button and hold for 3 seconds again – the padlock symbol will disappear.

Responsive Consumption Display (Eco-Bar)



up to 20.5°C - Low consumption: the radiator is set optimally.



from 21°C to 23.5°C - Medium consumption: it is advisable to save energy consumption by reducing the temperature setting.



from 24°C - Max consumption: indicates the appliance is using maximum energy.

Programming – Quick Guide

Setting Time

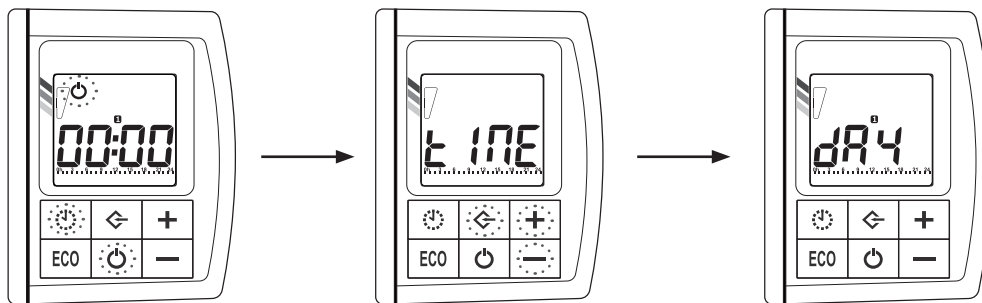

in Stand by mode , press and hold Time button

Chose **Time** using -/+ buttons and select with Mode button.

Day starts blinking.

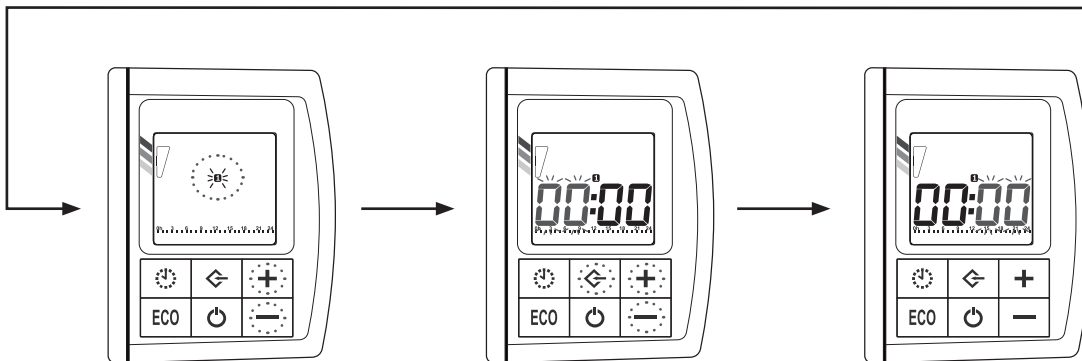

Chose week day (1-7) -/+ , confirm pressing Mode button

Select Hour -/+ cofirm pressing Mode button

Select Minutes -/+ cofirm pressing Mode button

Setting Programme

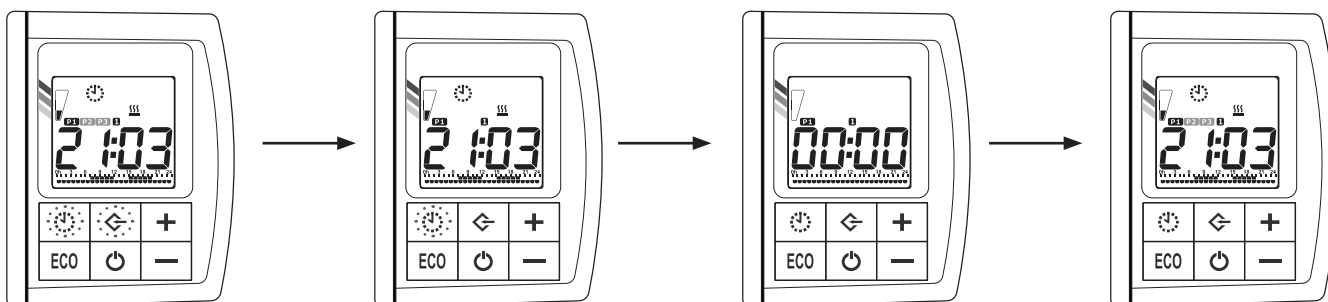

Press until clock appears on display. Press Time button to Select P1, P2 or P3.

Hold Time button to modify selected program

Press + to add Comfort period, press - to add Eco periods. Active hour appears on display number

Confirm and change to next day pressing Mode button. Setting of the day will be stored for next day.

Functions Menu

Once power has been supplied to the radiator it will initially be in the standby mode.

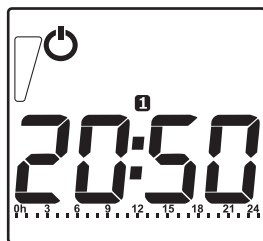

stand by

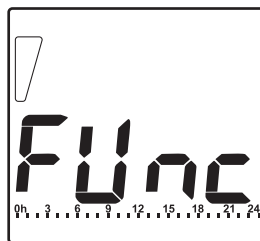

Function

Setting Functions

1. In the Stand-by mode press and hold the time button for more than 3 seconds.
2. Press the + or - button to select Time or Function, press mode to chose Function.
3. First choice is Open Window Detection, with buttons + or - , chose ON or OFF to activate this function, press mode to validate.

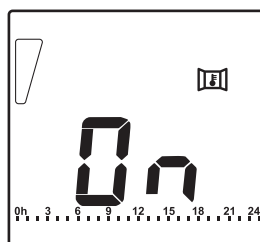
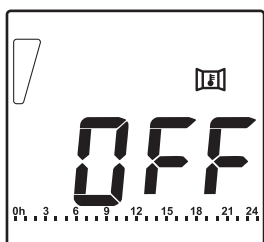

4. Second choice is ASC (Adaptive Start Control), with buttons + or - , chose ON or OFF to activate this function, press mode to validate.

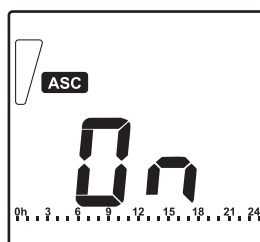
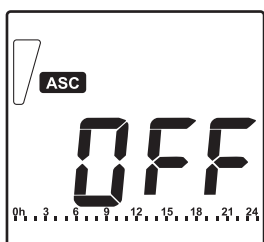

Adaptive Start Control ASC (Eco-Start)

With this feature activated the radiator will learn what time it should switch on to achieve the required room temperature at a particular time.

The heater will monitor the room temperature over 10 days to establish how quickly the room reaches temperature and uses this information to switch the heater on at the correct time.

By reaching the required temperature at the set time and not before, energy use and running costs are reduced.

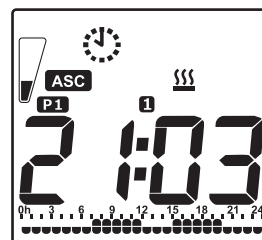

Open Window Detection

The “Open Window Detection” function enables detecting of an open window by sensing a sudden decrease of the temperature in the room. In such a case, the device deactivates the heating element for a maximum of 30 minutes, at which point the radiator will resume to operate in the previously set state.

When this function is enabled, the “Open Window” icon is shown on the display.

When the device detects that the window is potentially opened, the “Open Window” icon starts blinking.

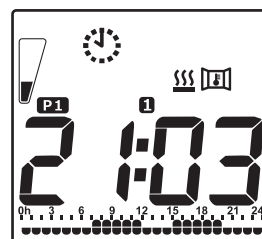

The Remote Control (Optional)

General Description

The remote control communicates with the radiator using infra-red signal from a maximum distance of 10m from the appliance and requires 2x AAA batteries.

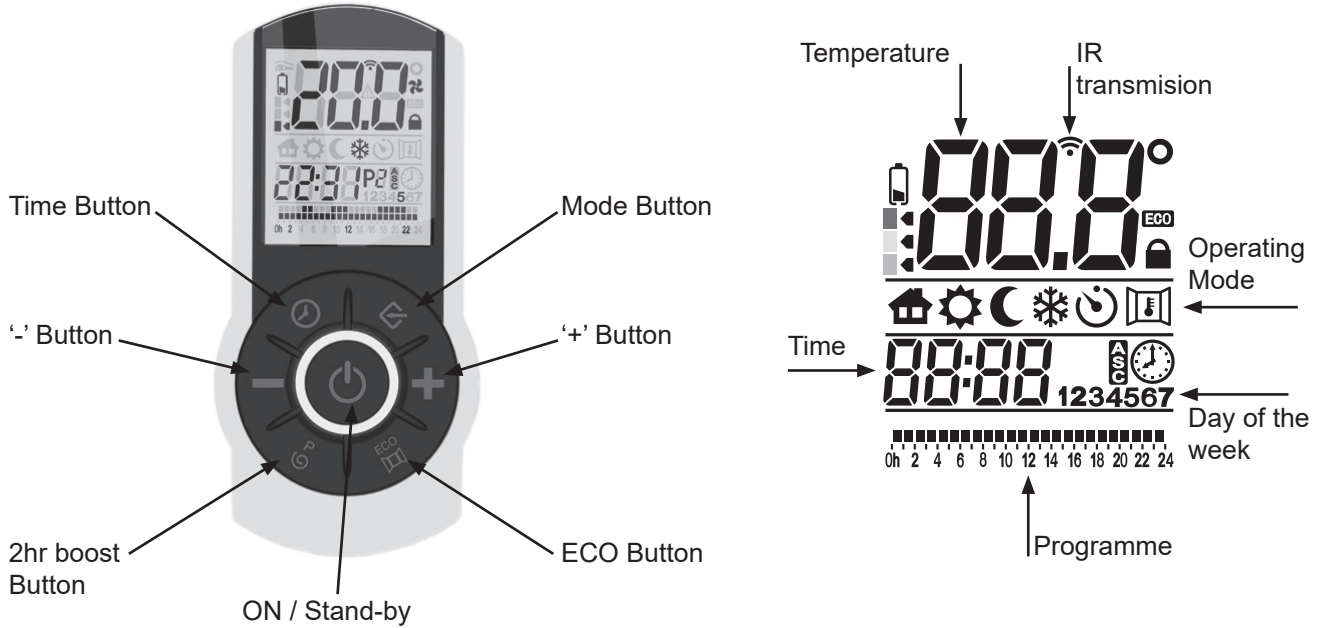

Setting the Time

Once the batteries have been installed the LCD screen will display all symbols for 3 second after which the date and time need to be set.

1. Set the day using the + or – button and press the mode button to accept.
2. Next set the hour using the + or – button and the mode button to accept again.
3. Set the minutes with the + or – button at which point pressing the mode button will accept the final change and the remote will go into stand-by mode.

Selecting the Operation Mode

The operation mode can be selected using the mode button; these are the same as those on the radiator and have the same function unless specified below.

Comfort and Economy Temperature Setting

To set the temperature for both the comfort and economy modes; select the desired mode using the mode button and set the temperature using the + or – buttons. The economy temperature can never be set higher than the comfort temperature.

Programme Mode

To set the user programme press the time button and the current day will flash. Accept the day, hour and minutes using the mode button, after which the user programme can be selected in the same method as completed on the radiator control end.

ECO mode

The “ECO” function can be used to reduce the electric consumption when the room is not occupied for a certain period.

To enable the function, press the dedicated [ECO] button. Every temperature previously set is lowered by 3°C. The “ECO” icon is shown on the display.

To disable this function, press again the [ECO] button.

IR Transmission

Any alterations made using the remote control will be sent to the radiator via an IR signal after 1 second of inactivity. This can be seen by the IR transmission  symbol flashing in the top right hand corner.

Keypad lock

This function allows the user to lock the keypad on the remote to avoid inadvertent changes. It also locks all the buttons apart from the standby button. To enable the Keypad lock function, press both the mode and + buttons together for 3 seconds. To disable the function, repeat the same procedure.

OPEN WINDOW DETECTION FUNCTION

To enable the “open window detection” function, press both the ECO and - buttons together for 3 seconds.

To disable the function, repeat the same procedure.

2-Hour Boost

This mode will force continued heating for 2 hours independent of room temperature, after this time the radiator will return to the previously operated mode.

To activate press the 2-Hour Boost button, 2H will now be shown on the display of both the radiator and the remote. To cancel press the 2-Hour Boost button.

Low Battery Warning

When the battery level is low, the correspondent icon will appear on the display. Replace the batteries as soon as possible.

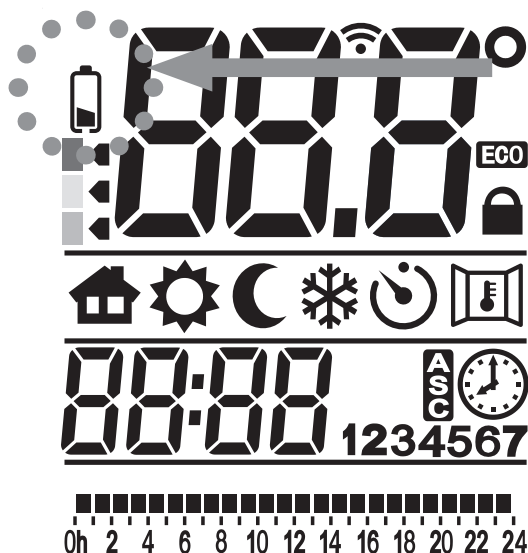



Ducasa Single Zone Remote Programming Quick View Instructions

Make sure remote shows a symbol in between the 2 lines, above the clock. If not press 



First set the date and time by pressing 

Use +/- to select the day (1=Monday, 7=Sunday)
then press 

Use +/- to select the hour then press 

Use +/- to select minute then press 

To change Comfort and Economy temperatures

Press  until Comfort () is shown & then set temperature using +/- then press 

Set Economy () temperature using +/- then press  until  is shown on remote.



Sending program to heater

Press  to turn remote to Standby.

Point remote at the heater & then press 



Once the screen flashes, your program has been transmitted to heater & heater running program

To change a program

Press  and then press  3 times

To create a program





You select the mode required for each hour of the day starting from midnight Monday

You will choose from either Comfort () by pressing + or Economy () by pressing -

Repeat for every hour of the day

Once satisfied with programme for day 1 press 

Repeat previous 4 steps for the next 6 days

	Standby
	Time/Program
	Comfort
	Economy
	Mode/OK

LoT 20 Table

Models	DPL 10	DPL 15	DP 450	DP 600	DP 900	DP 1200	DP 1500	DP 1800
Heat output								
Nominal heat output (P_{nom})	0.95kW	1.42kW	0.45kW	0.6kW	0.9kW	1.2kW	1.5kW	1.8kW
Maximum continuous heat output ($P_{max,c}$)	0.95kW	1.42kW	0.45kW	0.6kW	0.9kW	1.2kW	1.5kW	1.8kW
Auxiliary electricity consumption								
At nominal heat output (eI_{max})	0.00076 kW	0.00076 kW	0.00076 kW	0.00076 kW	0.00076 kW	0.00076 kW	0.00076 kW	0.00076 kW
At minimum heat output (eI_{min})	N/A	N/A	N/A	N/A	N/A	N/A	N/A	N/A
In standby mode (eI_{SB})	0.00035 kW	0.00035 kW	0.00035 kW	0.00035 kW	0.00035 kW	0.00035 kW	0.00035 kW	0.00035 kW
Type of heat output/room temperature control:	Electronic room temperature control plus week timer							
Other control options:	Room temperature control, with open window detection With adaptive start control, With working time limitation.							
Heattend Products Ltd, https://www.heattend.co.uk/ Email: enquiries@heattend.co.uk								

MAINTENANCE AND CARE

Ducasa radiators require very little maintenance.

The surfaces of the radiator must not be cleaned with an abrasive product or those containing granular substances. We recommend regular cleaning with PH neutral products. In order to clean the radiator, it is recommended that the electric power is switched off.

Guarantee

Your appliance is guaranteed for 10 years against leakage and 2 years on electric and electronic components from the date of purchase – during this period we will repair or exchange, at our discretion, any faulty or defective parts providing the appliance has been used in accordance with the operating & installation instructions and has not been misused or mistreated in any way.

Any unauthorised repair or attempted repair will invalidate the guarantee.

This guarantee is additional to your statutory rights.

In the unlikely event of a problem with your appliance please contact your supplier.

Correct Disposal of This Product

(Waste Electrical & Electronic Equipment)

(Applicable in the European Union and other European countries with separate collection systems)

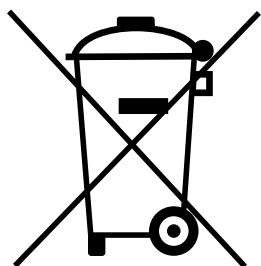

This marking shown on the product or its literature, indicates that it should not be disposed of with other household wastes at the end of its working life.

To prevent possible harm to the environment or human health from uncontrolled waste disposal, please separate this from other types of wastes and recycle it responsibly to promote the sustainable reuse of material resources.

Household users should contact either the retailer where they purchased this product, or their local government office, for details of where and how they can take this item for environmentally safe recycling.

Business users should contact their supplier and check the terms and conditions of the purchase contract. This product should not be mixed with other commercial wastes for disposal.



UK Distributor of Ducasa Products:

Heattend Products Ltd

Web: www.heattend.co.uk

Email: enquiries@heattend.co.uk