

# ducasa

## AVANT-DGP

Thermal Electric Radiator

Operating and Installation Instructions

(Read these instructions carefully and retain for future reference)

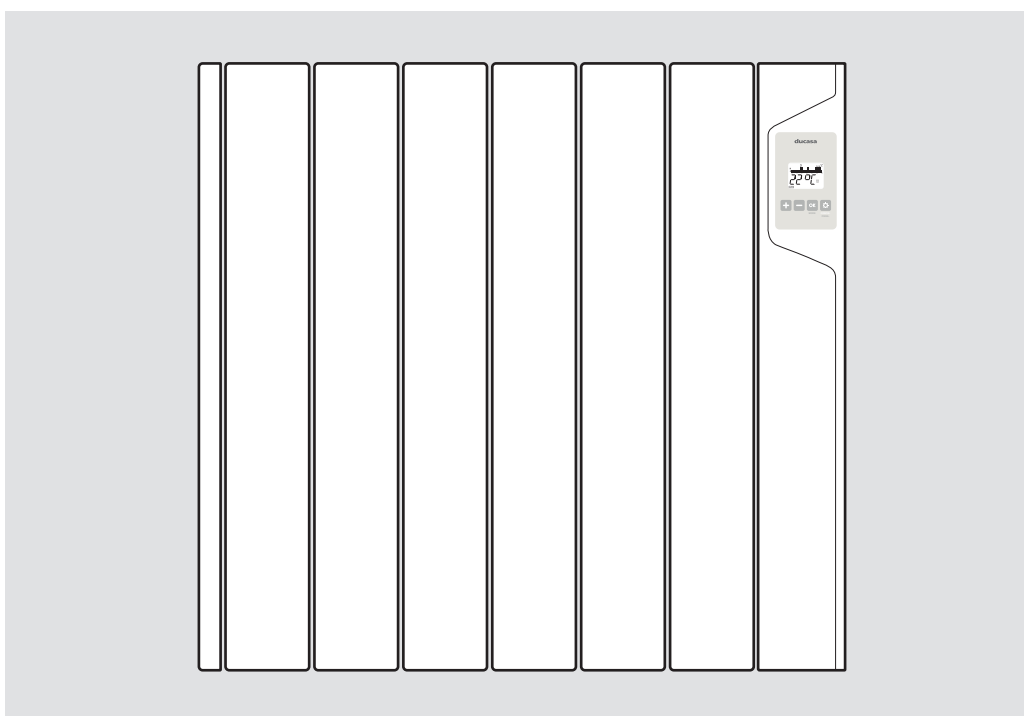

### Models:

**AVANT-DGP 350**  
**AVANT-DGP 500**  
**AVANT-DGP 750**  
**AVANT-DGP 1000**  
**AVANT-DGP 1250**  
**AVANT-DGP 1500**  
**AVANT-DGP 1800**

### NOTE:

A qualified electrician must carry out the electrical installation of this radiator. The electrical installation must comply with the current UK regulations. Any claim on the warranty could be invalid if these requirements have not been met.

IMPORTANT SECURITY INFORMATION . . . . . 3

Technical Data . . . . . 5

GENERAL INFORMATION . . . . . 5

INSTALLATION INSTRUCTIONS . . . . . 6

OPERATING INSTRUCTIONS . . . . . 9

CONTROLS . . . . . 9

STAND-BY FUNCTION . . . . . 9

MAIN SWITCH . . . . . 9

MODE SELECTION . . . . . 10

CHARACTERISTICS . . . . . 10

ADJUST PROGRAMMED TEMPERATURES . . . . . 10

SETTING PROGRAMME AND CLOCK . . . . . 11

KEYPAD LOCKING (ANTI-TAMPER) . . . . . 11

ADVANCED SETTINGS . . . . . 11

HEATER RESET . . . . . 13

Quick Guide to Manual Programming . . . . . 15

MAINTENANCE AND CARE . . . . . 16

Guarantee . . . . . 16

Correct Disposal of This Product . . . . . 16

## IMPORTANT SECURITY INFORMATION

- This appliance can be used by children aged 8 years and above and persons with reduced physical, sensory or mental abilities or lack of experience and knowledge, if they have been given supervision or appropriate training regarding the use of the device in a safe way and they understand the dangers involved.
- Children should not play with the appliance. Cleaning and maintenance should not be performed by unsupervised children.
- Children under 3 years should be kept out of reach of the appliance unless they are constantly supervised.
- Children between age 3 and younger than 8 years old should only turn on / off the device whenever it has been placed or installed at its normal operating position provided they are supervised or have received instructions concerning use of the appliance safely and understand the risks that the device has. Children from 3 years and under 8 years old should not plug in, regulate, clean the appliance or perform maintenance.
- Warning: Some parts of this product can become hot and cause burns. Pay particular attention when children and vulnerable people are present.
- Heaters must be installed correctly following the specific requirements of the Installation Instructions section below.



**Warning: in order to avoid over heating the unit, do not cover the heaters. This symbol “DO NOT COVER”, is placed on the heater as a reminder to the user.**

### ATTENTION:

- The heaters must not be covered by clothing, containers or any other objects that may block the air ventilation.

### VERY IMPORTANT:

The “OFF” indicator shown on the heater’s control panel does not mean disconnection of the heater from the power supply and should be understood as a standby condition. To ensure the heater is completely off and without access to the power supply, it is recommended to disconnect it from the power supply by removing the fuse from the spur outlet. Alternatively, change the mechanical switch on the side of the heater to “OFF”.

- The unit must be placed away from flammable objects and children must not be left unattended when the heater is heating.
- The heater should not be located underneath any electrical connection.
- The electric supply line should be protected with a high sensitivity differential device (RCBO).
- Do not use the heater to dry clothes.
- Heaters must not be installed in places where there are risks of splashes such as next to bathtubs, sinks, etc.
- If the power cord is damaged, it must be changed by the manufacturer, its after-sales service or persons qualified to do so, to avoid possible danger
- Anyone who is in the bathtub or shower should not have access to the switches or other power operation devices. Always keep at least 0.6m (UK) or 3.0m (Ireland) between the radiator and the bath or shower.  
(UK: Outside zone 2, Ireland: Outside zone 3)
- The radiator must be installed so that around the radiator there is sufficient space for proper circulation of hot air, with a minimum distance of 150 mm to curtains, furniture, etc

- All repairs where required must be completed by the manufacturing company or by special authorised staff.
- If the heater is sold without cable and plug or any other disconnecting method, the installer must incorporate a disconnecting device taking into account the specific regulations that apply.
- This heater has been designed and created as a fixed heating device and must be used for this purpose only.
- The heater must be mounted directly to the wall using the brackets supplied with the heater.
- Do not place the heater directly on the floor.
- Make sure that the wall where the heater is going to be mounted is suitable to bear the heater's weight.
- Use the correct fixing for the type of wall the heater is to be mounted onto.
- Make sure that the electrical power supply corresponds to the information indicated on the heaters rating label.
- The heater must be levelled correctly both vertically and horizontally.
- When the heater is operational, the power cord must be totally unrolled and must not touch the surface of the unit.
- Do not operate the heater with wet hands.
- Before undertaking any type of maintenance, ensure that the heater is disconnected from the power supply by removing the fuse from the spur outlet.

## TECHNICAL DATA

MODEL	Number Of Fins	Power Rating (W)	Size (mm)	Net Weight (Kg.)	Fuse Rating
Avant-DGP 350	3	350	340 x 580 x 100	6.9	5 Amp.
Avant-DGP 500	4	500	420 x 580 x 100	8	5 Amp.
Avant-DGP 750	6	750	580 x 580 x 100	12	5 Amp.
Avant-DGP 1000	8	1000	740 x 580 x 100	16	10 Amp.
Avant-DGP 1250	10	1250	900 x 580 x 100	20	10 Amp.
Avant-DGP 1500	12	1500	1060 x 580 x 100	24	10 Amp.
Avant-DGP 1800	12	1800	1060 x 580 x 100	24	10 Amp.

## GENERAL INFORMATION

The Avant DGP has a special cast aluminium body specifically designed to assure maximum rate of heat radiation; the air circulation channels providing a very efficient convection effect.

Special heat conducting fluid in the aluminium body. A unique process provides bubble free filling so that the fluid delivers warmth from the heating element in a totally uniform way, ensuring that the entire surface of radiator provides comfortable heat.

Monotube heating element to ensure maximum heat output.

Designed and fabricated in accordance with EN 60335-1, EN 60335-2 and EN 55014 (regulations for domestic appliances)

Standard colour White (RAL 9016)

Class I

Wall mounted (by quick fixing system)

Bi-metallic thermal cut-out

On-off main switch

Overheat protection

Key-pad locking (anti-tamper)

NTC electronic sensor

Fitted with connecting power cable 1450mm long (without a plug)

## Electrical Connection

A qualified electrician must carry out the electrical installation of this radiator. The electrical installation must comply with the current UK regulations. Any claim on the warranty could be invalid if these requirements have not been met.

The radiator requires a 230/240V 50/60Hz power supply.

Connecting wires:

**Brown: Live**

**Blue: Neutral**

**Yellow-green: Earth**

The connecting wires must be of the appropriate section, in regards to the length of cable, type of cable and power rating of the apparatus.

The apparatus must be connected into a fused connecting box or a plug fitted with an appropriate sized fuse for the radiator – see Technical Data on Page 3.

We recommend that the connecting box is positioned 10cm to the right of the apparatus and at 15cm above the floor. According to regulations, the apparatus must be connected to the power supply by means of an all-pole circuit breaker with a contact gap of at least 3mm or by a thermal-magnetic circuit breaker.

## Location

The ideal place to site the Ducasa radiator is as close as possible to coolest wall in the room but it is not recommended to site the radiator on un-insulated exterior walls, in this case, the part of the wall behind the radiator should be insulated.

In bathrooms, the radiators must not be sited inside the protected area. The control unit switches must not be reachable, directly or indirectly, by a person in the bath or shower.

The radiator, under no circumstances, should be installed below an electric power point.

Choose the location of the radiator in respect of the minimum distances that are indicated in Figure A.

Fig. A

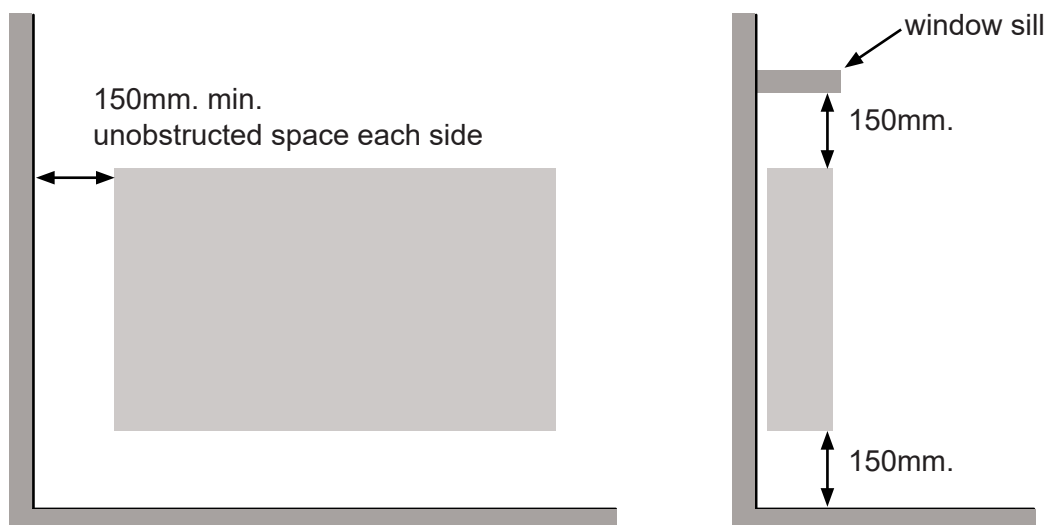

## Mounting The Radiator

Place the radiator on the floor, as shown in Figure 1. For radiators with 4, 6, 8 or 10 elements position the supports supplied with the radiator as shown in Figure 1. For radiators with 12 elements the supports should be positioned between the second and third elements on both sides.

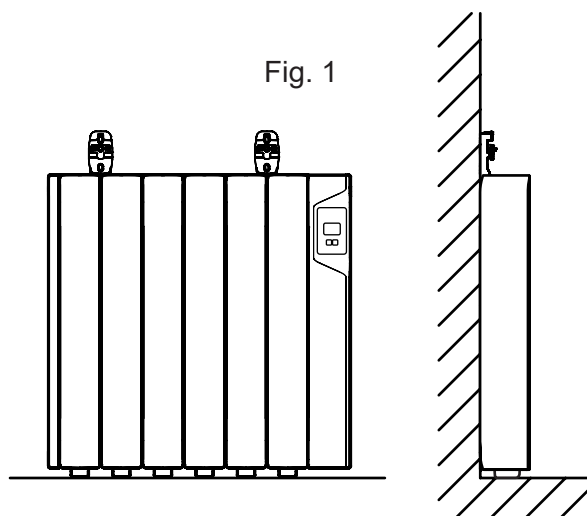

Place the supports between the elements as shown in Figure 2a, mark points on the walls through the fixing holes as shown in Figure 2b. This determines the spacing of the supports. Transfer these marks to whatever height above floor (min. 150mm) that has been decided for the radiator. Fix the supports to the wall with plugs and screws. Be sure that the supports are mounted in the correct position.

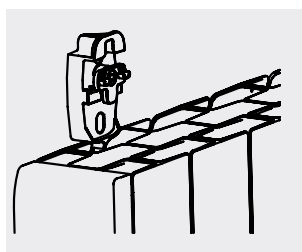

Fig. 2a

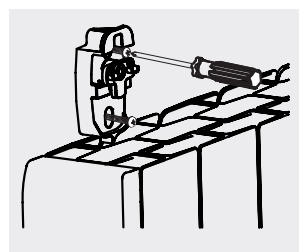

Fig. 2b

Lift the radiator and hang it on the supports, as Figures 3a and 3b.

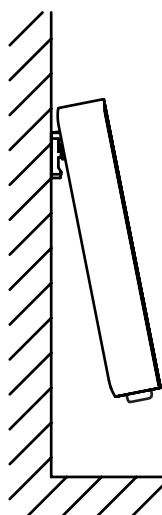

Fig. 3a

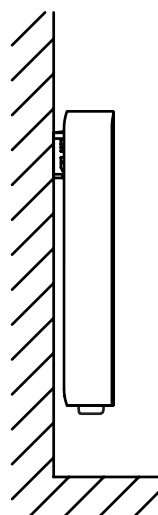
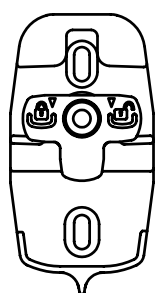
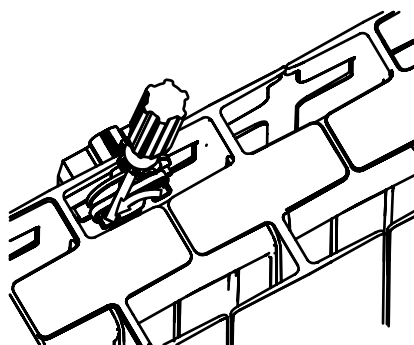

Fig. 3b

As soon as the radiator is hanging on the supports press on the locking plate until a click is heard. See Figure 4. The radiator is now installed.

Fig. 4



FREE

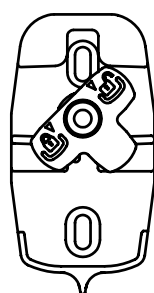

LOCKED

Place the wall spacer as Figure 5.

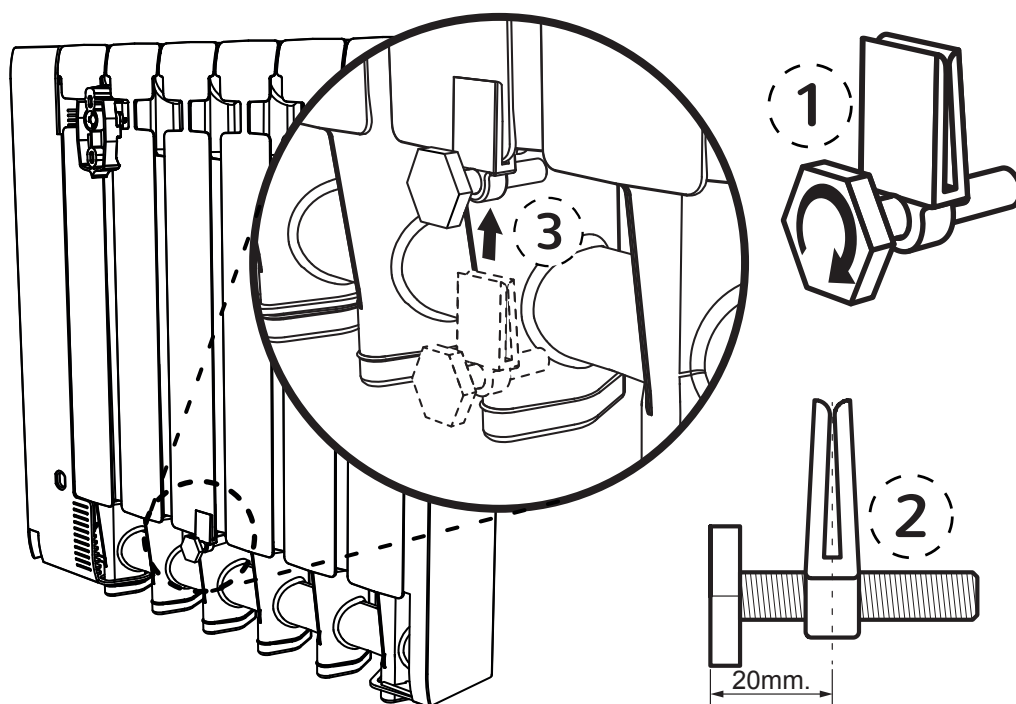

Fig. 5



# OPERATING INSTRUCTIONS

## CONTROLS

The control is based on four buttons and a LCD display.

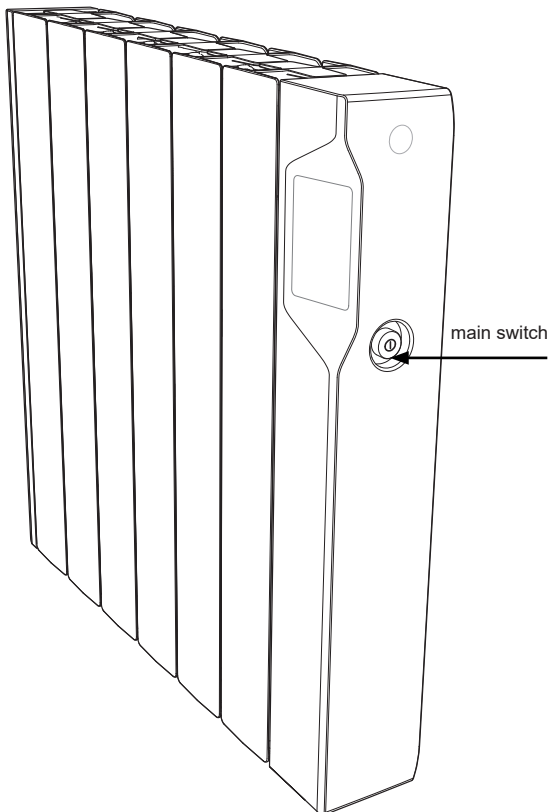
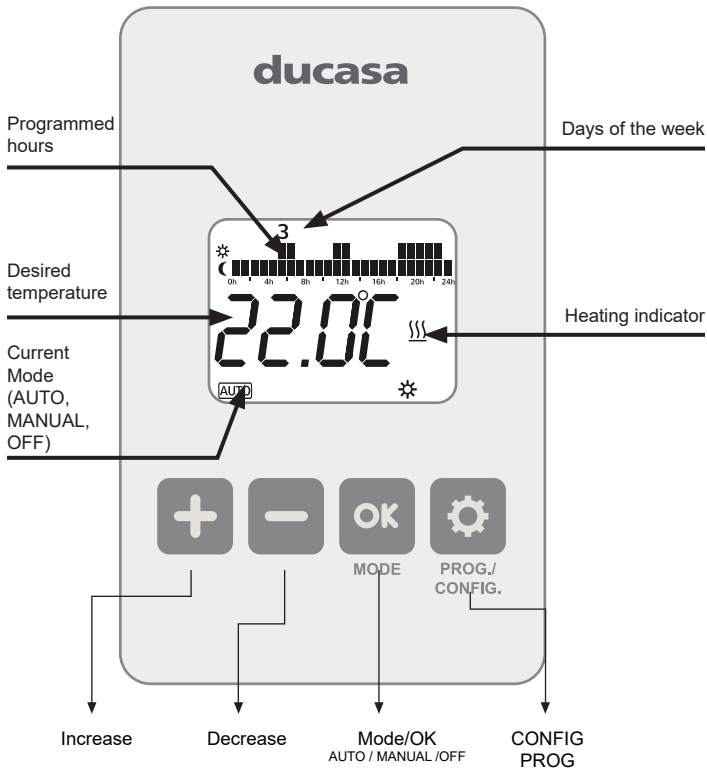

## STAND-BY FUNCTION

Press the **Mode/OK** button until the **OFF** symbol is present as shown in the following screen.

When the heater is in Stand-by Mode it will retain programmes but will not heat.



To return the heater to a heating mode, press the **MODE** button to choose programme mode (**AUTO**) or **MANUAL** mode .

## MAIN SWITCH

There is also a main On-Off switch on the right hand side of the control panel.

### Switching ON (Master):

Once the heater has been mounted on the wall and correctly connected to the main electricity power supply, press the main On-Off switch on the right hand side of the heater so that it's in the "on" position.

After around 3 seconds the screen will show various information and the heater is ready to work.

### Switching OFF (Master):

To switch off the heater press the main On-Off switch so that it's in the "off" position. The LCD screen will be blank.

### NOTE:

- In the event of a power cut the current mode of operation and all set values including the program will be retained.

If the power cut lasts more than 20 minutes, the clock information will be lost.

- When powered on for the first time, the heater starts in the **OFF** mode. When powered on after the initial start-up, it will return to the last mode it was in prior to shutting down unless it was in the **AUTO** mode, in which case it starts in the **OFF** mode.

## MODE SELECTION

The following screens show **MANUAL**, **AUTO** and **OFF** modes. To choose different modes press **MODE/OK** button.

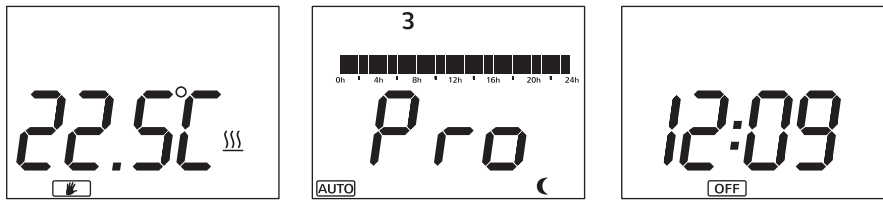

When the heater is in **AUTO** mode the temperature can be changed by pressing the **+/-** buttons. This change will remain active until the next programme change or until midnight when the temperature will revert to the preset value.

When the heater is in **MANUAL** mode use the **+/-** buttons to alter the set temperature.

## CHARACTERISTICS

To assist with programming the LCD screen is backlit and will stay illuminated for approximately 10 seconds after the last button is pressed.

When the heater is operational and the room temperature is lower than the set temperature the heating symbol will be shown indicating that the heater is producing heat. When the room temperature equals or is above the set temperature the heating symbol will not be present indicating the heater is not producing heat.

## ADJUST PROGRAMMED TEMPERATURES

Adjusting the temperature in the following way will only affect the temperatures used for programmed modes.

To change these set up temperatures press the **CONFIG** button and the following screen appears:

When the temperature setup icon  starts flashing, press **MODE/OK** button to scroll through each temperature mode.



Press the **+/-** buttons to change the temperature of each temperature mode then press **OK** button to confirm and go to the next temperature.



To exit to the temperature setting screen press **CONFIG** button.

## SETTING PROGRAMME AND CLOCK

To start programming press and hold **CONFIG/PROG** button for 3 seconds and the following screen will appear:

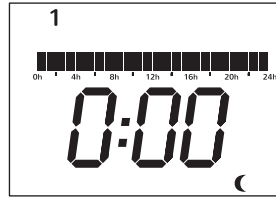

Programming starts on Monday at 00:00 and is set by choosing the required Mode for each hour of the week. Use the **OK** button to choose between Comfort, Economy or Frost Protection modes. On the screen, programme hours will show two blocks for Comfort, one block for Economy and no blocks for frost protection. After choosing the temperature mode press the **+/-** buttons to select the next hour to be programmed. When a full day has been programmed the screen moves to the next day. This is signified by a number from 1 to 7 in the top left side of the screen.

Once each day of the week has been programmed the clock must be set.

Once you have programmed 23:00 on day 7, the heater will automatically enter the time setting screen.

To select the day of the week (1=Mon, 7=Sun) press the **+/-** buttons and confirm with the **OK** button. Next select the hour and confirm with **OK** button and then select the minutes and confirm pressing **OK** button once more.

## CHANGING DAY / CLOCK ONLY

To change the clock without going through the programme first ensure the heater is in Standby, then:

Press and hold Config for 3 seconds. Press Config once. Use **+/-** to set the day (1=Mon 7=Sun). Press **OK** then **+/-** to set hour. Press **OK** then **+/-** to set minute. Press **OK** to finish.

## KEYPAD LOCKING (ANTI-TAMPER)

The keypad can be locked to prevent any unauthorised person (children, people in public places, nurseries, offices, hotels etc.) altering the settings of the heater. To lock the keypad press and hold the **+** and **-** buttons at the same time for 3 seconds until "Lock" appears on the screen.

Once set, any button presses will be ignored and "Lock" will be displayed on the screen.

To unlock keyboard, once again press and hold **+** and **-** for 3 seconds until the word 'Lock' disappears.

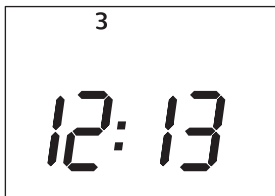

## ADVANCED SETTINGS

To enter the advanced settings mode, press **CONFIG** button while the heater is in one of the main modes (OFF, AUTO, MANUAL). The following window will appear:



Now press the **CONFIG** button for 5 seconds and C1 appears on the screen.

To select one of the advanced settings (C1 to C6) use the **+/-** buttons keys and choose the required mode by pressing **OK** button. The advanced settings are:

1. C1-> Choose °F or °C
2. C2-> Choose Type of Control
3. C3-> Temperature Compensation
4. C4-> Firmware Version
5. C5-> Open Window Detection
6. C6-> Eco-Start

### Degrees Fahrenheit or Celsius (C1)

Select °C or °F with the +/- buttons and confirm with OK button.

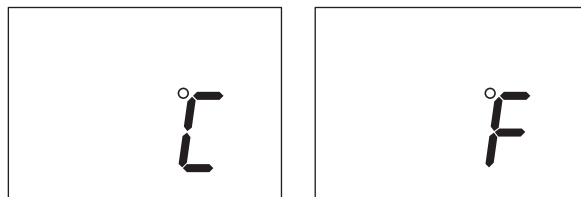

### Type of Control (C2)

This advanced setting shows the type of control currently used. There are 5 types of control: PID, hysteresis of 0.25°C, hysteresis of 0.35°C, hysteresis of 0.50°C and hysteresis of 0.75°C.

To change the type of control press +/- . Confirm with the **OK** button.

The screens shown are:

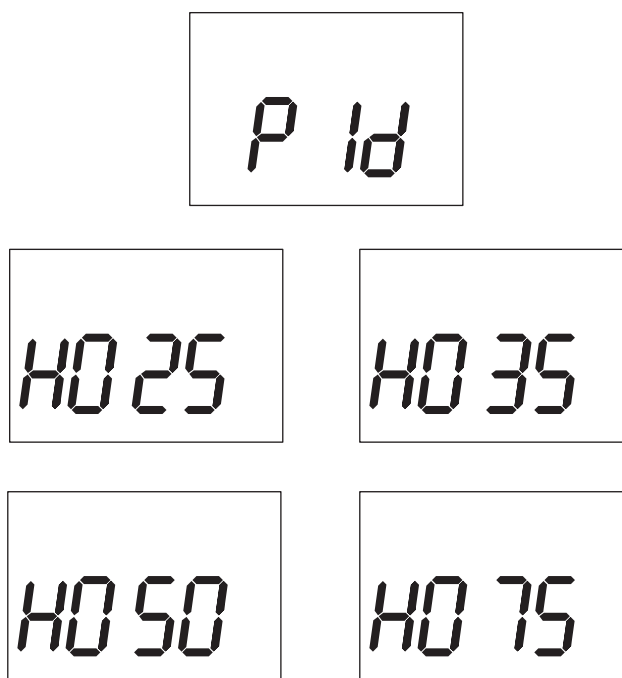

### Temperature Compensation (C3)

In this mode the display will alternate between the temperature compensation (offset) and the measured temperature with the offset applied. Alter the offset with the +/- buttons and confirm with the **OK** button.

Temperature compensation can be adjusted up to +/- 3°C.

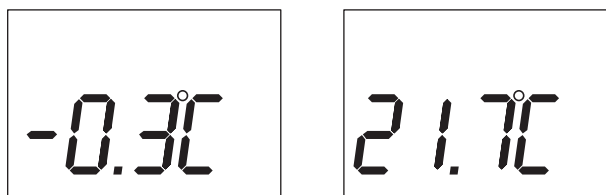

### Firmware Version (C4)

It shows internal software installed in the electronics.

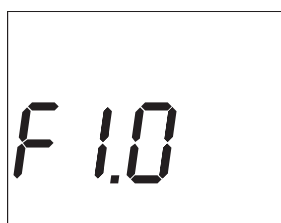

## Open Window detection (C5)

In order to save energy, if a window opens and causes a sudden drop in temperature the heater will stop heating.

By default this function is deactivated. To change the status of the function, press the +/- button and then press the **OK** button to confirm.

This function detects a temperature drop of 0.6°C every minute over a period 4 minutes.

If the heater is heating, it will be disconnected for 30 minutes and shows the Open Window icon on the display.

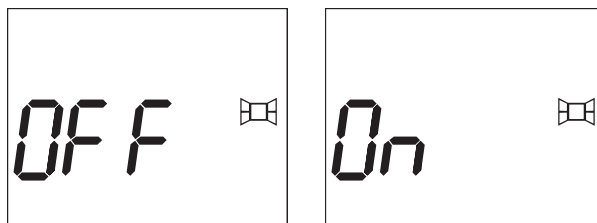

The heater will restore normal function in any of these situations:

- After 30 minutes
- If the temperature increases by 0.2°C within 1 minute from the point of activation.
- Pressing any button on the Heater

## Eco-Start (C6)

With this feature activated the heater will learn what time it should switch on to achieve the required room temperature at a particular time.

The heater will monitor the room temperature over 10 days to establish how quickly the room reaches temperature and uses this information to switch the heater on at the correct time.

By reaching the required temperature at the set time and not before, energy use and running costs are reduced.

By default this function is deactivated.

To change the status of the function, press the +/- button and then press the **OK** button to confirm.

If this function is active then  will be shown on the program screen.

This function doesn't work in MANUAL mode, it only works in the PROGRAM mode.

If the heater is reset, all previous Eco-Start data will be deleted.

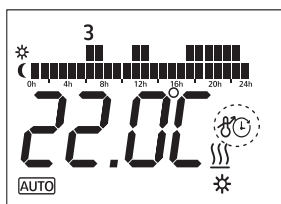

## HEATER RESET

Resetting the heater will return all settings to the factory defaults and will also delete any stored programming and temperature data.

To activate the RESET feature press the **OK** button and the **CONFIG** button together for 10 seconds. The following screen will appear:

To confirm the reset, press the **OK** button again, to cancel the **RESET** press any other button.

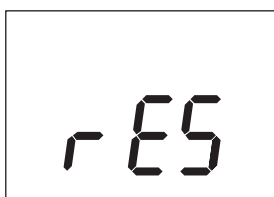

## Default Values

- Working Mode: OFF
- Comfort Temp : 19°C
- Economy Temp : 17°C
- Frost Protection Temp : 5°C
- Manual Mode Temp: 19°C
- Temperature Compensation: 0°C
- Temperature Units °C
- Control Type: PID
- Default Programme: All Economy
- Open Window Detection OFF.
- Eco-Start OFF

Models	Avant DGP 350	Avant DGP 500	Avant DGP 750	Avant DGP 1000	Avant DGP 1250	Avant DGP 1500	Avant DGP 1800
<b>Heat output</b>							
Nominal heat output ( $P_{nom}$ )	0.35kW	0.5 kW	0.75 kW	1.0 kW	1.25 kW	1.5 kW	1.8 kW
Maximum continuous heat output ( $P_{max,c}$ )	0.35kW	0.5 kW	0.75 kW	1.0 kW	1.25 kW	1.5 kW	1.8 kW
<b>Auxiliary electricity consumption</b>							
At nominal heat output ( $eI_{max}$ )	0.00037 kW	0.00037 kW	0.00037 kW	0.00037 kW	0.00037 kW	0.00037 kW	0.00037 kW
At minimum heat output ( $eI_{min}$ )	0.00037 kW	0.00037 kW	0.00037 kW	0.00037 kW	0.00037 kW	0.00037 kW	0.00037 kW
In standby mode ( $eI_{SB}$ )	0.00037 kW	0.00037 kW	0.00037 kW	0.00037 kW	0.00037 kW	0.00037 kW	0.00037 kW
<b>Type of heat output/room temperature control:</b>	Electronic room temperature control plus week timer						
<b>Other control options:</b>	Room temperature control, with open window detection. With adaptive start control.						
<b>Heattend Products Ltd,</b>  <a href="https://www.heattend.co.uk/">https://www.heattend.co.uk/</a>  Email: enquiries@heattend.co.uk							

# Ducasa Avant DGP

## QUICK GUIDE TO MANUAL PROGRAMMING

The Avant DGP radiator is programmed by using heating 'modes'.  
The modes are set for each hour of the week, starting from midnight on Sunday  
The days are numbered 1 to 7, with 1 being Monday and 7 being Sunday

The 'modes' are:  
☀ **Comfort**    ☾ **Economy**    ❄ **Frost Protection**

**There are 3 steps to programming your heater;**  
**1.Programming the Modes 2.Setting the Clock 3.Setting the Temperatures**

### Programming the Modes

Press ⚙ Prog / Config for 3 Seconds  
Press OK to choose the mode and '+' to confirm for each hour of each day  
If you make a mistake press '-' to go back  
When you are happy the modes are correct press ⚙ to move onto setting the clock

### Setting the Clock

Use +/- to select the current day, 1 =Mon 7=Sun  
then press OK  
Use +/- to set the hour  
then press OK  
Use +/- to set the minute  
When you are happy the clock is correct press ⚙ to move onto setting the temperatures

### Setting the Mode Temperatures

Use + / - to select 📏 then press OK  
Use +/- to set the ☀ comfort temperature then press OK  
Use +/- to set the ☾ Economy temperature then press OK  
Use +/- to set the ❄ Frost Protection temperature then press ⚙  
Press OK until **AUTO** is shown on screen  
Programming is complete

### **Notes & Tips:**

When the radiator is running in Auto the set temperature can be changed by pressing +/-  
At the next programmed mode change, the radiator will return to the pre-set temperature

It can be useful to write down the times and modes you want before starting to programme the radiator

The screen backlight switches off after 10 seconds and the radiator exits programme mode.  
If this happens you will need to press ⚙ Prog / Config for 3 seconds and re-enter your modes.

## MAINTENANCE AND CARE

Ducasa radiators require very little maintenance.

The surfaces of the radiator must not be cleaned with an abrasive product or those containing granular substances.

We recommend regular cleaning with PH neutral products.

In order to clean the radiator, it is recommended that the electric power is switched off.

## GUARANTEE

Your appliance is guaranteed for 10 years against leakage and 2 years on electric and electronic components from the date of purchase – during this period we will repair or exchange, at our discretion, any faulty or defective parts providing the appliance has been used in accordance with the operating & installation instructions and has not been misused or mistreated in any way.

Any unauthorised repair or attempted repair will invalidate the guarantee.

This guarantee is additional to your statutory rights.

In the unlikely event of a problem with your appliance please contact your supplier.

## CORRECT DISPOSAL OF THIS PRODUCT

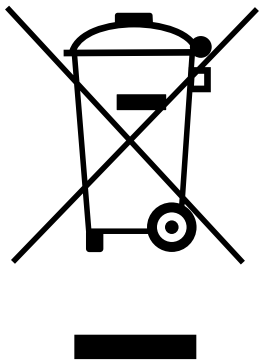

(Waste Electrical & Electronic Equipment)  
(Applicable in the European Union and other European countries with separate collection systems)

This marking shown on the product or its literature, indicates that it should not be disposed of with other household wastes at the end of its working life.

To prevent possible harm to the environment or human health from uncontrolled waste disposal, please separate this from other types of wastes and recycle it responsibly to promote the sustainable reuse of material resources.

Household users should contact either the retailer where they purchased this product, or their local government office, for details of where and how they can take this item for environmentally safe recycling.

Business users should contact their supplier and check the terms and conditions of the purchase contract. This product should not be mixed with other commercial wastes for disposal.



UK Distributor of Ducasa Products:

Heattend Products Ltd

Web: [www.heattend.co.uk](http://www.heattend.co.uk)

Email: [enquiries@heattend.co.uk](mailto:enquiries@heattend.co.uk)